

**Micro***tronics*<sub>at</sub>



**Micro***tronics*<sub>at</sub>

**Wireless Measurement Technology**



## Microtronics is Manufacturer of Wireless and Optical Measurement Systems

- laser and optical technologies
- wireless, mobile MicroPower<sup>®</sup> instruments (few  $\mu$ A)
- manufacturing of ATEX-instruments
- ISO9001 and ISO13980 certified production center

Fields of Engineering:

- optics
- mechanics
- electronics
- software



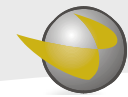

# The Future of Centralised Data Collecting Systems

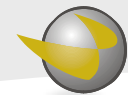

## **Demands on Global Collecting Systems**

- international application
- energy efficiency
- international clientele
- availability
- mobility
- low costs of installation and operation
- little expenditure of time
- high reliability
- “Plug and Play“
- promptness
- scalability
- possibilities for service and maintenance

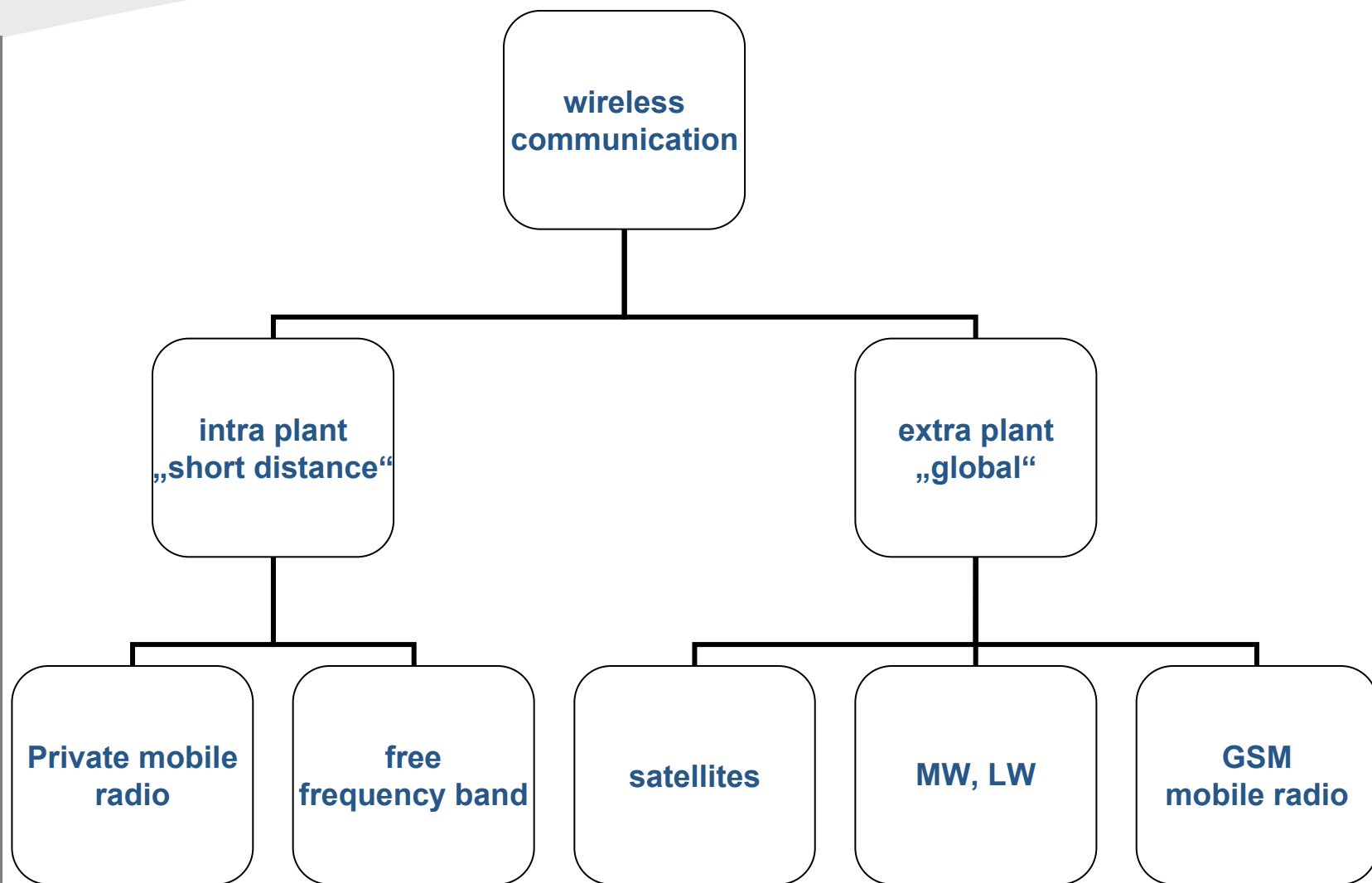



## **GSM Global System for Mobile communications**

- worldwide standardized
- high availability due to good GPRS network coverage
- well priced terminal
- simple to verify
- low operating costs possible!
- maintained radio network via provider
- „by-product“ of the consumer goods industry = der Konsumindustrie  
= price advantage
- known and tested technology

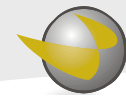

## Forms of Utilisation of GSM

- SMS data transfer
- GSM data transfer
- GPRS/EDGE data transfer



## **GSM Data / SMS Data**

### Advantages:

- Has been the only possibility to transfer data via GSM network in the past.

### Disadvantages:

- very expensive due to time based billing
- only point-to-point connection possible
- very slow
- inference-prone
- little data volume
- for international solutions very expensive
- for SMS transfer of M2M very long round trip times
- unsecured connections



## The Past of GSM Data Transfer

- point-to-point connections
- leased lines to remote measurement points
- SMS as data transmitting medium – 160 characters at 7 bit
- GSM – GSM connections point-to-point
- serial internet tunnels for ISO OSI layer 7 connection



## The Past of GSM Data Transfer

### Advantages:

- many solutions on the market

### Disadvantages:

- high operating costs
- not or only very difficult to scale
- bad connection quality
- loss of data
- central maintenance only in little practicable
- low energy efficiency
- piggyback technology
- a server has to be online
- only a few simultaneous connections in central systems (in theory 250 -> in practice 20)

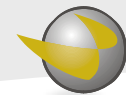

## The Present and the Future of GSM Data Transfer

- central data collecting system
- star topology
- global clientele
- TCP/IP protocol based transmission ISO OSI layer 4
- broadband service of the mobile radio network provider

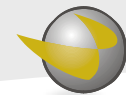

## The Present and the Future of GSM Data Transfer

### Advantages:

- low costs – even for global connection (Skype-effect)
- central data management
- central configuration
- summary of information
- secure connection due to direct TCP/IP communication of measurement points and collecting systems
- many simultaneous connections -> typ. 50.000 – 100.000
- reduced protocol-stack for lower error rate
- higher protocol- and energy efficiency
- high Backbone availability

### Disadvantage:

- A server has to be online.

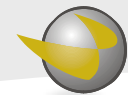

# What is possible?

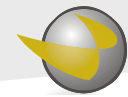

- up to 50.000 device connections simultaneously
- up to 1.500.000 measurement points in the system
- graphics of minute-measurements for one year in a few seconds
- charges from 2.50 euros total per month
- low hardware requirements
- battery powered for several years

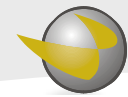

## Wireless Communication



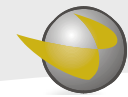

**Micro***tronics*<sub>at</sub>

**Wireless Communication**

**Thank you for your  
attention.**